

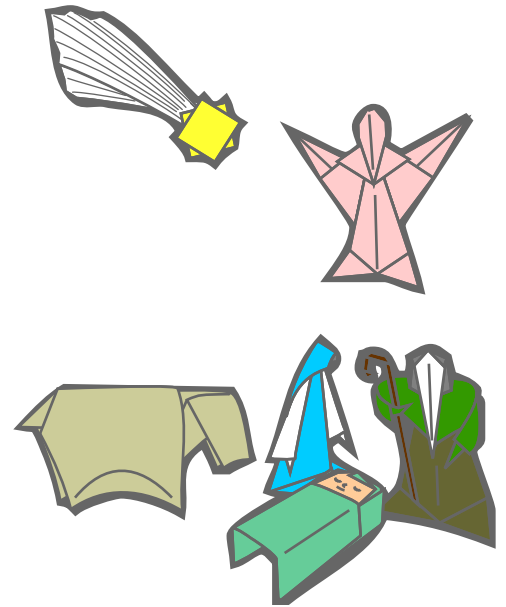

Das Auto.

Feliz reciclaje 2008

www.bosquebluemotion.com/recicla

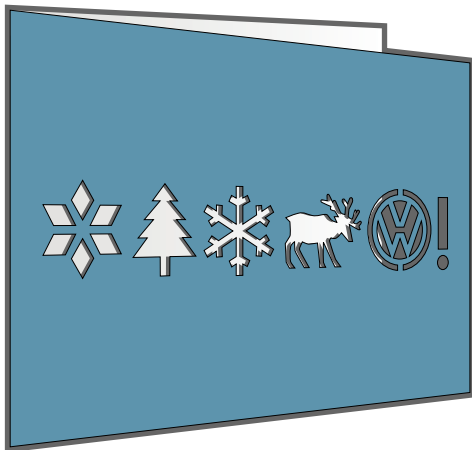

Crea un Belén de papiroflexia



Imprime sólo en caso de utilizar las plantillas. Estas Navidades piensa en el medio ambiente.

.1

Guarda todas las felicitaciones de Navidad que recibas este año. No importa el tamaño. Con ellas puedes hacer un Belén de papiroflexia.

.2

Para hacer las figuras deberás seguir las instrucciones ilustradas de abajo. Es muy fácil, sólo se necesita un poco de habilidad y paciencia. ¡El resultado merece la pena!

.3

Un consejo: utiliza las tarjetas más pequeñas para hacer los complementos de las figuras; las grandes, para el cuerpo o elementos más grandes. El color también puede servirte para orientarte a escoger las tarjetas más idóneas.

San José



Piernas y Pies

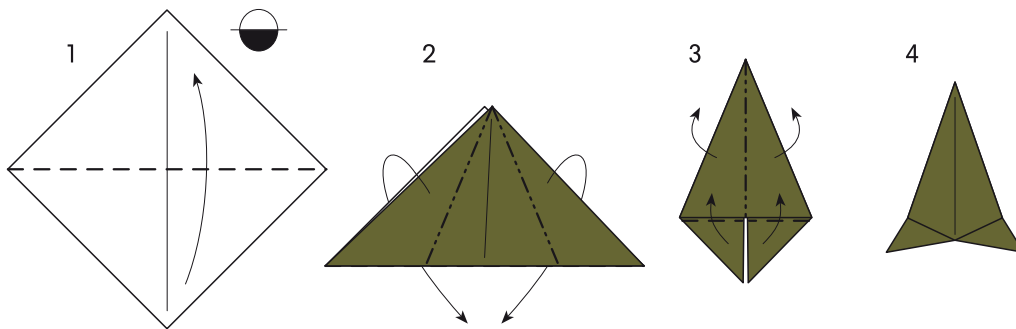

Pecho y Brazos

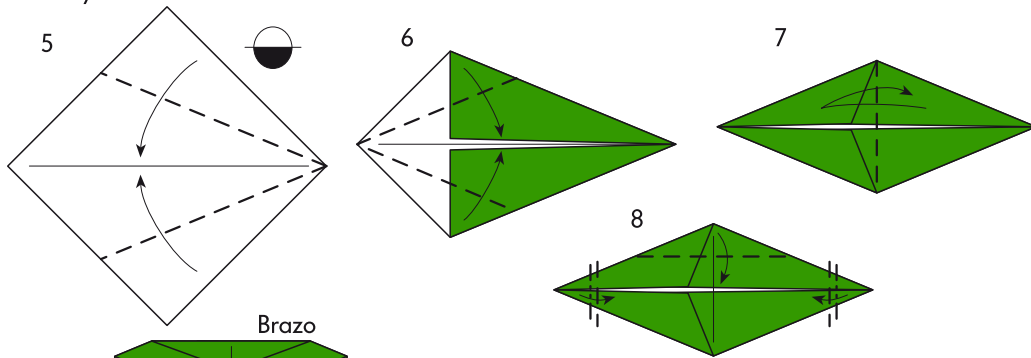

Brazo

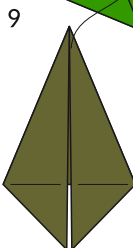
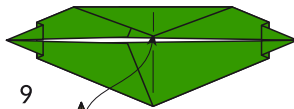

Piernas vistas por detras

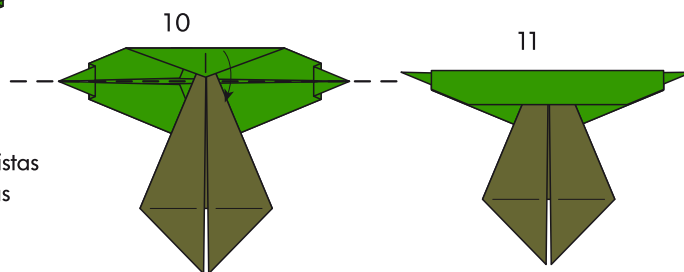

Cabeza y Barba

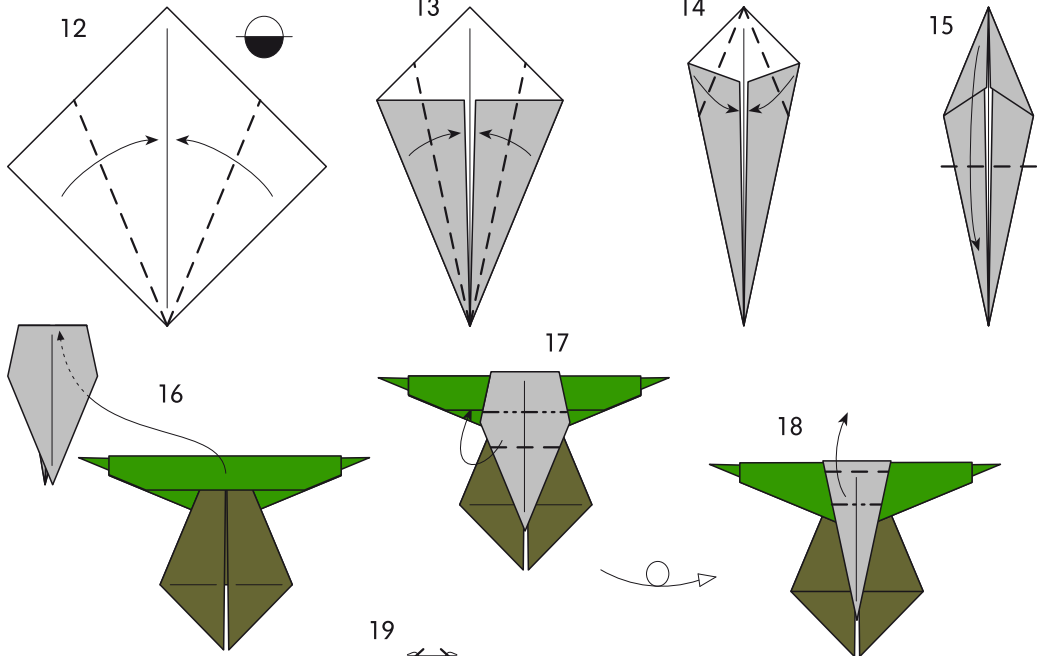

Báculo

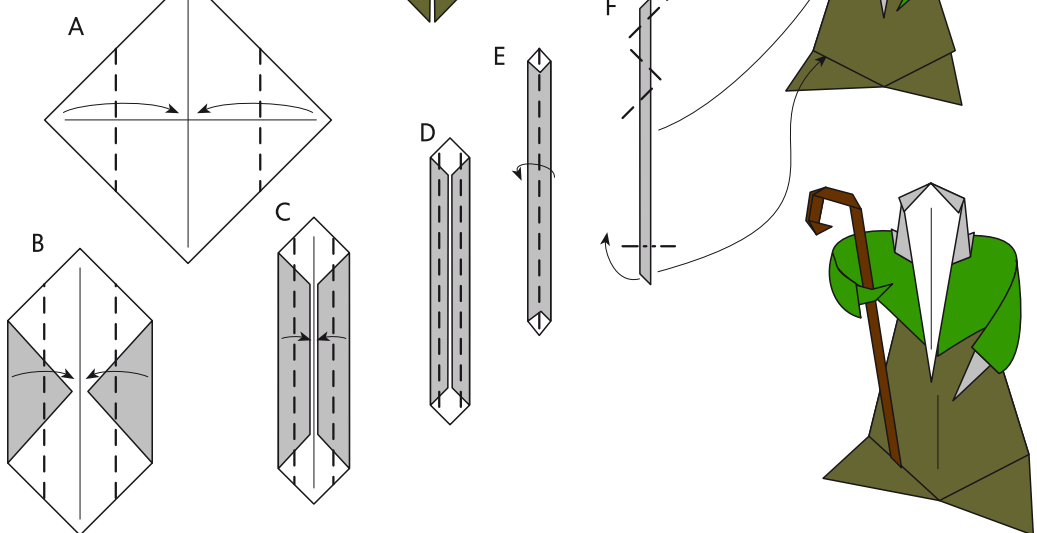

Niño Jesús

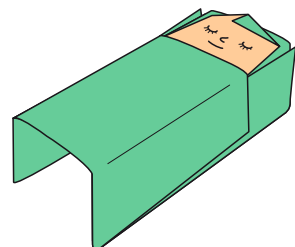
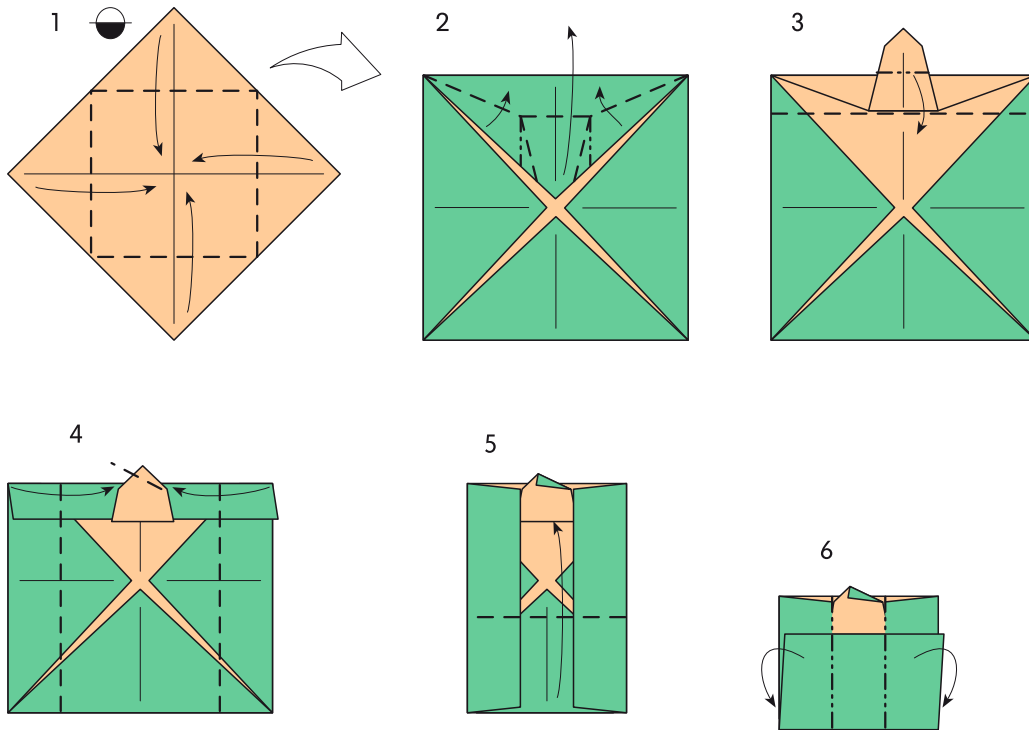
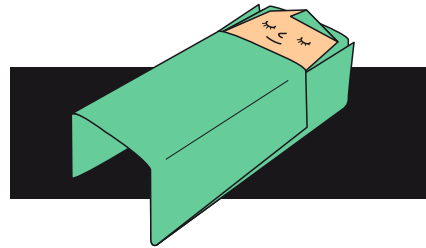

Virgen María

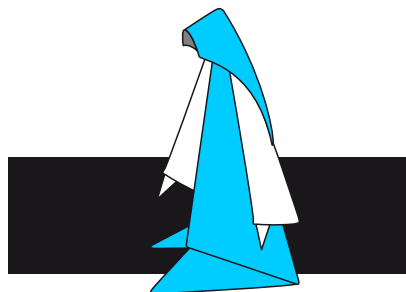

Tronco y Pies

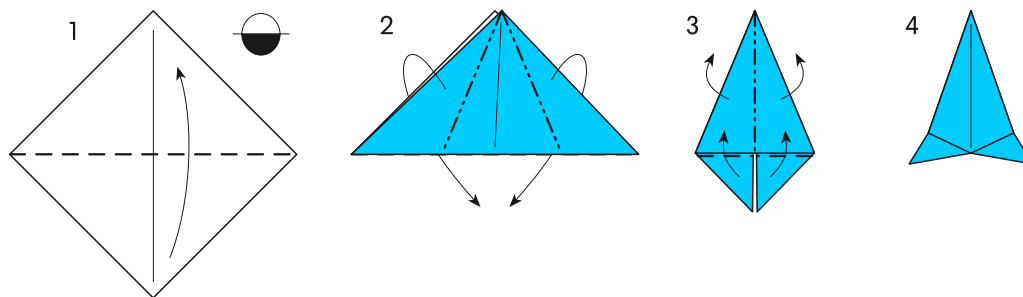

Brazos y Velo

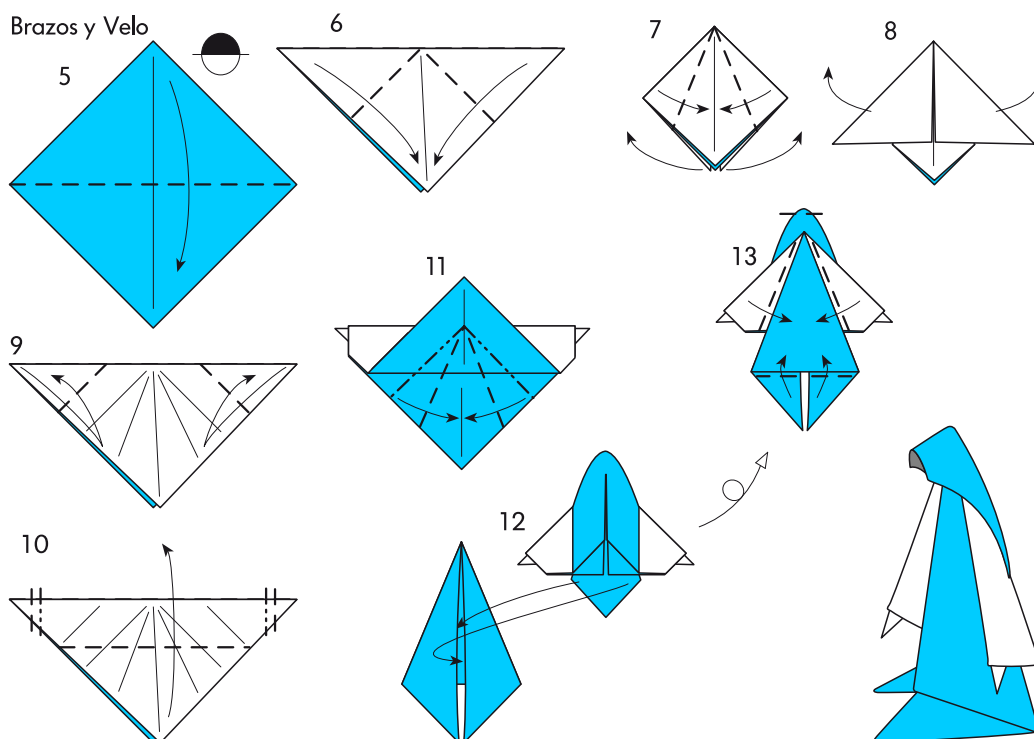

Oveja

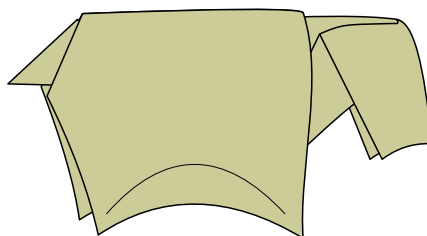
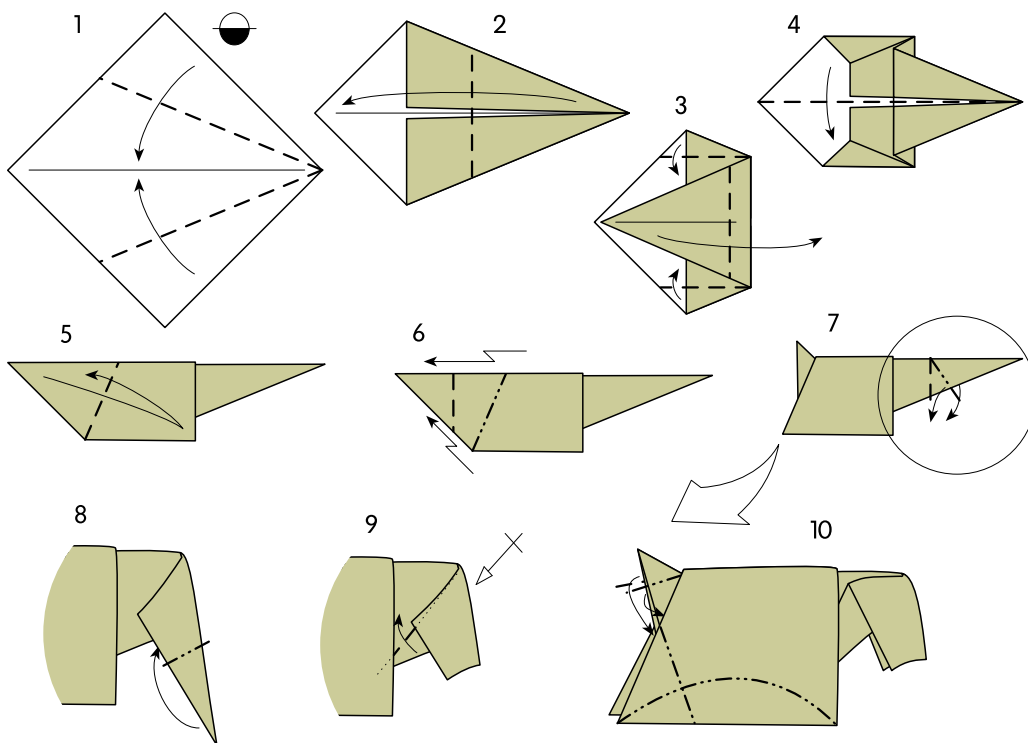
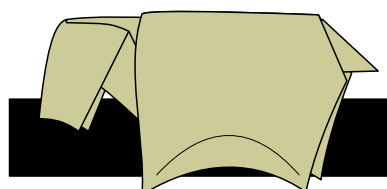

Estrella de Belén

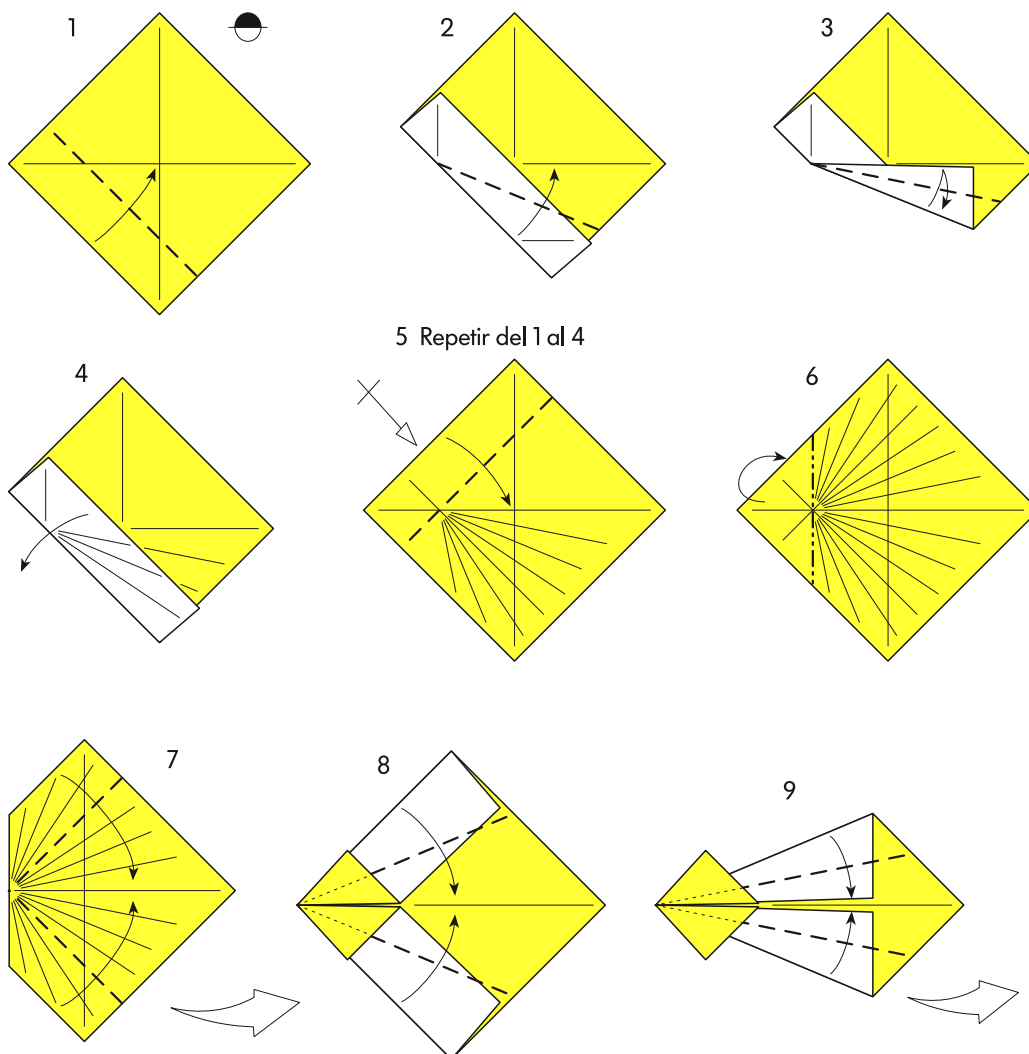
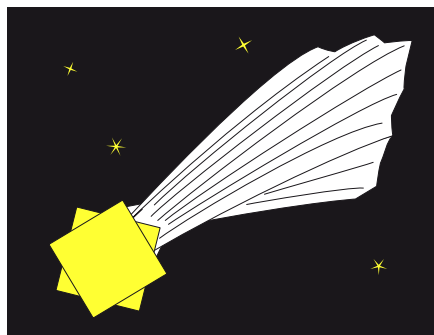

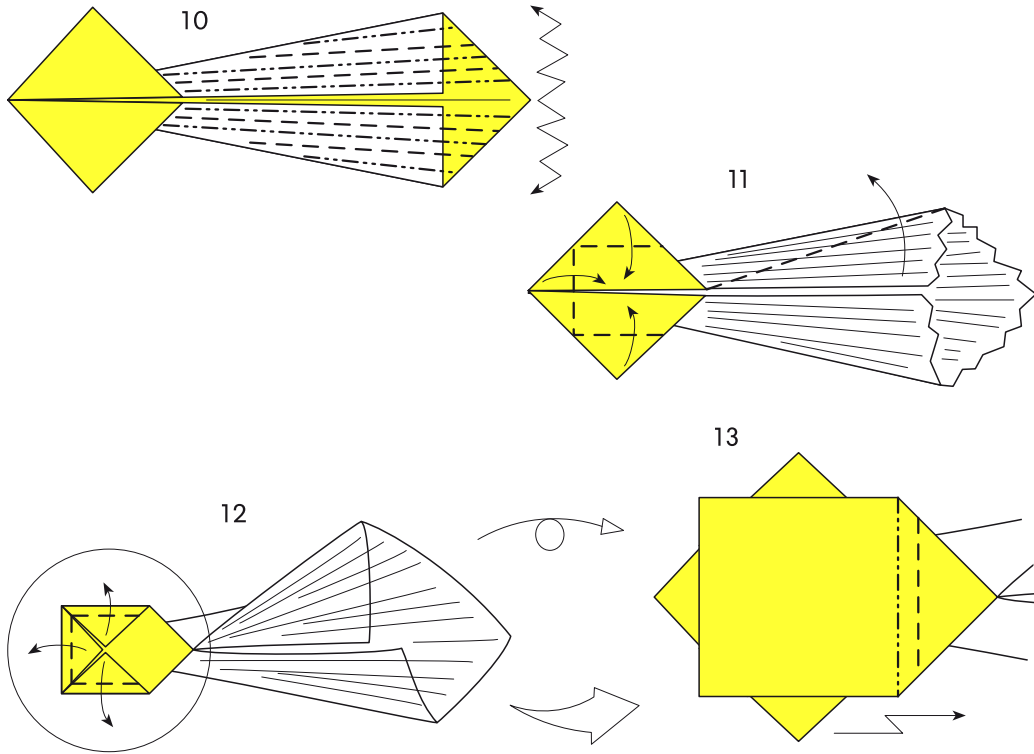

Ángel

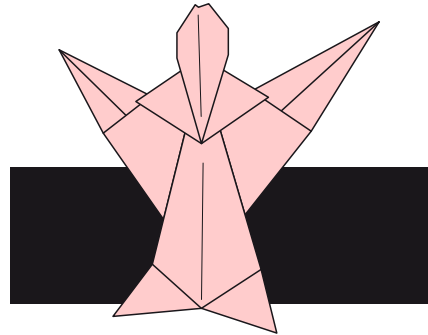

Piernas y Pies

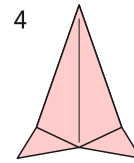
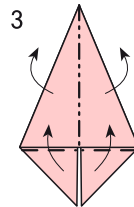
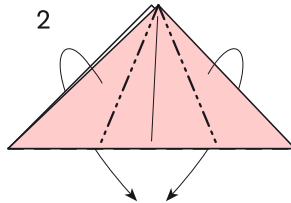
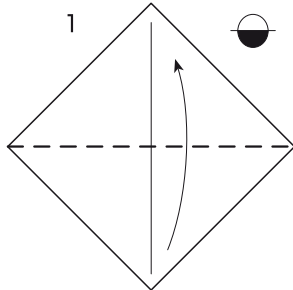

Cuerpo

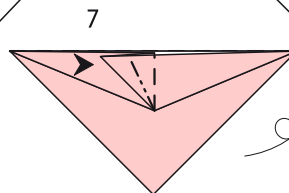
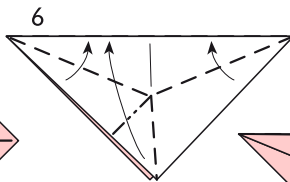
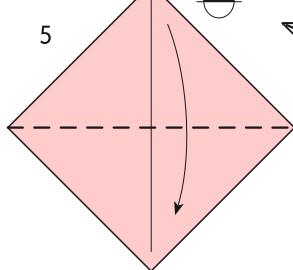

8 Marcar solo el final

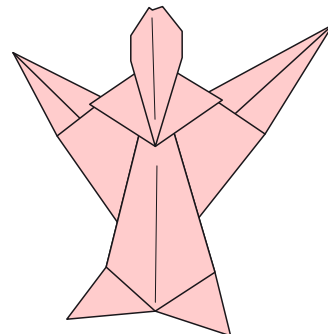
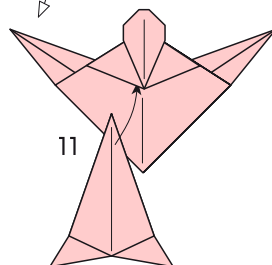
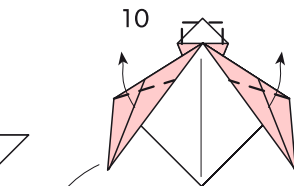
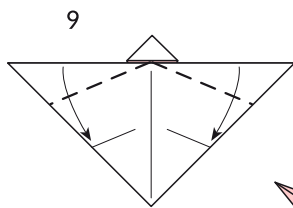
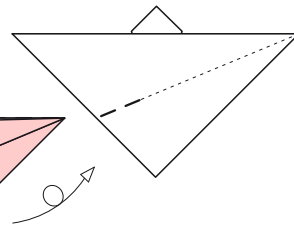

Das Auto.